



RIZZI ENGINEERING

*General Information on our Company*

MKS : 2.009

Comp. LD

Date : 07/01/2008

Contr. IC

Sheet : 1 of 31

Verif. DL

RIZZI ENGINEERING s.r.l. Via Nespolo, 8 - 25030 ADRO - Brescia - ITALY

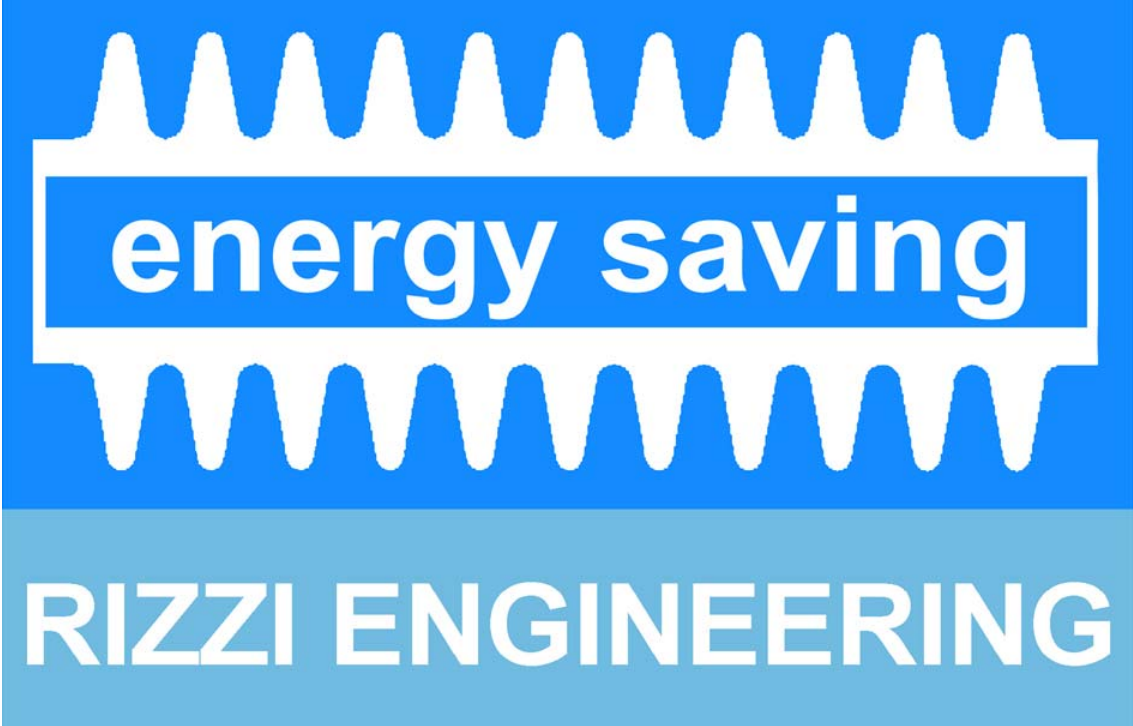

***GENERAL INFORMATION  
ON OUR COMPANY***

**MKS-RIENG 2.009**

**CONTENT**

<b>I° GENERALITIES</b>	page 4
1.1 Data of our company	
1.2 Addresses	
1.3 Main areas of activity	
<b>II° HOW TO FIND US</b>	page 5
<b>III° OUTLINE OF THE COMPANY HISTORY</b>	page 6 ÷ 7
<b>IV° COMPANY STRUCTURE</b>	page 8
<b>V° MANAGEMENT</b>	page 9
<b>VI° SALES ORGANIZATION</b>	page 10 ÷ 11
6.1 Worldwide operations	
6.2 Agents network	
6.3 After sales service	
<b>VII° PRODUCTION PROGRAM</b>	page 12
<b>VIII° PRODUCTS AND MAIN DESTINATIONS</b>	page 13 ÷ 14
8.1 Petrochemical industry and oil refineries	
8.2 Marine field	
8.3 Solar energy and renewables field	
8.4 Electric power stations	
8.5 Steel and metallurgical industry	
8.6 Sugar mills - paper mills - textile industry	

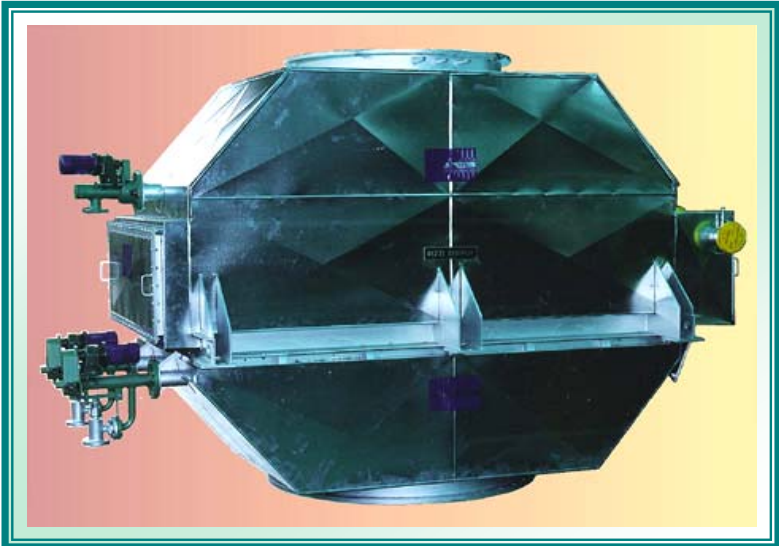

<b>IX° DESIGN AND ENGINEERING SERVICES</b>	page 15
9.1 Specific know-how	
9.2 Facilities	
9.3 Calculation systems	
9.4 Patents and technologies	
<b>X° TESTING FACILITIES</b>	page 16÷18
<b>XI° WORKSHOP</b>	page 19÷20
11.1 Resuming features	
11.2 Facilities	
11.3 Finning equipments	
11.4 Combustion air preheater bay	
11.5 Clean areas	
11.6 Health & safety assurance	
<b>XII° QUALITY ASSURANCE SYSTEM</b>	page 21÷28
12.1 General description	
12.2 Third Parts Inspection and Testing	
12.3 Typical third parts Inspection approvals	
12.4 International rules and standars	
12.5 Welding WPS	
12.6 ISO 9000 SQS Certificate	
12.7 ISO 9000 IQNet Certificate	
12.8 Achilles Certificate	
<b>XIII° CATEGORIES OF CUSTOMERS</b>	page 29
13.1 List of categories	
13.2 Main areas of activity	
<b>XIV° LIST OF CUSTOMER FOR TYPICAL SAMPLES</b>	page 30
<b>XV° BANK REFERENCES AND FINANCIAL DATA</b>	page 31

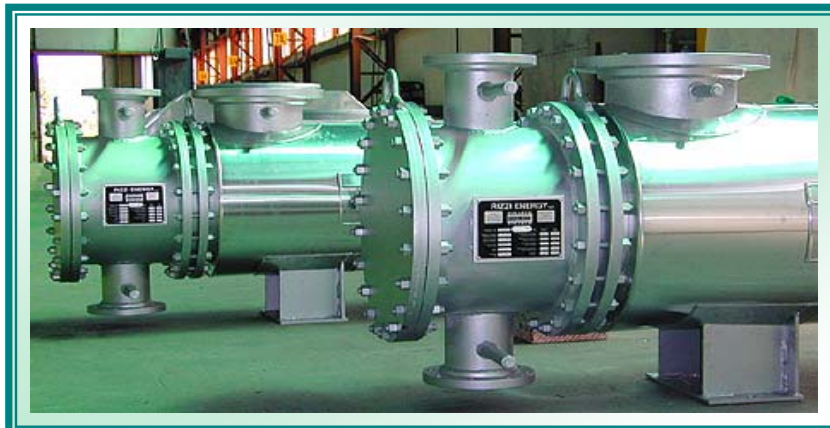



RIZZI ENGINEERING

## General Information on our Company

MKS : 2.009	Comp. LD
Date : 07/01/2008	Contr. IC
Sheet : 4 of 31	Verif. DL

RIZZI ENGINEERING s.r.l. Via Nespolo, 8 - 25030 ADRO - Brescia - ITALY

## I° GENERALITIES

### 1.1 DATA OF OUR COMPANY

Social style	RIZZI ENGINEERING s.r.l.
Fiscal Code	Nr. 02085430987
VAT register	Nr. 02085430987
Chamber of Commerce Registration	Brescia Nr. 76125
Court of Society Registration	Brescia Nr. 414102
Share paid-up capital	Euro 76.500

Our Company has been founded by private persons and does not belong to any national or international group.

### 1.3 MAIN AREAS OF ACTIVITY

#### 1.3.1 ELECTRIC POWER PLANTS – THERMAL PLANTS

- Thermal power stations
- Gas turbine and diesel-electric power stations
- Cogeneration plants - CHP

#### 1.3.2 PETROCHEMICAL INDUSTRY

- Oil refineries
- Chemical factories
- Petrochemical plants

#### 1.3.3 MARINE AND SHIPPING INDUSTRY

- Shipbuilding
- Conversion turboships – motorships and Shiprepairs
- Shipowners supply service

#### 1.3.4 SOLAR ENERGY

- Solar low pressure steam generators
- Solar flat panels for DHW
- Seawater desalting plants

## II° HOW TO FIND US

We are an European company, exactly an Italian one, placed in North Italy, 80 km east from Milan.



### **III° OUTLINE OF THE COMPANY HISTORY**

Our Company was founded in 1938 by Dr. Ing. Italo Rizzi: in those years Italy was suffering a severe oil and coal shortage and energy saving was already a hot problem. Consequently we started designing and manufacturing energy saving systems through heat recovery, mainly fuel economizers for preheating feed water of steam generators and soot blowers.

Roughly dividing the course of our Company's life chronologically we had at first, unfortunately, to face hard problems due to the world war II° and then we met three years of severe reconstruction problems. Since 1948 till now we have participated to the development of new technologies, new larger plants, new systems. Summarizing some trends of modern industry we have had, all over the world, the increase of working pressures and temperatures of steam generators, together with the growth of the size of the units in all thermal power stations.

In the same way, we have had the enormous blow up of oil industry due to larger and larger oil consumption, the increase of ships size, the development of steel and iron industries.

These facts required all our energies to find out new design approaches, to develop new technologies and the use of new materials, to develop new calculation methods and manufacturing processes, in one word required all our energies to develop our actual know-how.

In fifteen years, from 1950 to 1965, we had the rapid growth of packaged, transportable steam generators that jumped from only 5-6 tons per hour up to 150 and 200 tons per hour. We developed new packaged, transportable fuel economizers from 100 square meters of heating surface up to 4000 square meters. Of course we also developed new heat transfer surfaces and the use of new lighter materials.

In twenty years, from 1950 to 1970, the size of thermal power stations grew from 60 megawatts to 600 and more megawatts.

All ancillary equipments followed this increase: for instance long-stroke travelling soot blowers reached stroke lengths of more that ten meters starting from one meter of stroke length.

The decade from 1960 up to 1970 was also the interesting period of ships size explosion. Oceans were crossed by tankers, supertankers, large-crude-carriers, very-large-crude carriers. From 50.000 tons of dead weight, ships reached 500.000 tons of dead weight.

To move so large vessels steam turbine cycles and diesel engines made an impressive run toward higher power and higher efficiency.

We realized new large marine fuel economizers for steam ships, and large, high efficiency, exhaust gas boilers for motor ships.

During this period we developed new crude oil heating systems for very-large-crude-carriers in order to assure easy and economical pumping, small dead weights in tankers bottom and rapid installation on board.

### III° **OUTLINE OF THE COMPANY HISTORY**

Starting from 1960 up to 2000 we saw also a large growth of chemical and petrochemical industries and oil refineries, not only in industrialized areas, but also in developing countries. We have been present in this field with the design and construction of heat recovery systems downstream of furnaces and fired-heaters and other energy saving systems.

In 1973 industrialized world knew the sudden oil shortage and consequently "energy crisis" and "energy saving" became problems largely discussed. In 1976 we started also with activities in solar field.

In the following years one of the most important problems we contribute to solve has been the "RETROFITTING" and the "REPOWERING" of existing plants. In fact, in many cases, it is not convenient to build-up new plants and to eliminate the old ones, but is better to make a "REHABILITATION" of existing plants adding new equipments and increasing efficiency.

In 1985 being completely matured the globalization of the market we shut our Sales Office in Milan concentrating all activities in our headoffice in Adro.

In the period 1985 up to day we've continued to operate worldwide in the our main ares of activity, power stations, petrochemical, marine, steel industry and solar field. In fact also if problems rising in different fields have specific features - when dealing with energy saving systems - many problems have common roots. Consequently time by time we can transfer our know-how from one field to another with profitable results.

Our Company occupies an intermediate position between an engineering Company and a manufacturing Company: any system of ours, before realization, needs to carry out an impressive quantity of specialized engineering and then the realization is based on specialized heat transfer equipments.

Nowadays we are involved in some advanced technology for solar energy systems, waste heat recovery units for distributed energy systems, super large combustion air preheaters for hydrogen steam reformers in petrochemical field.



### IV° COMPANY STRUCTURE

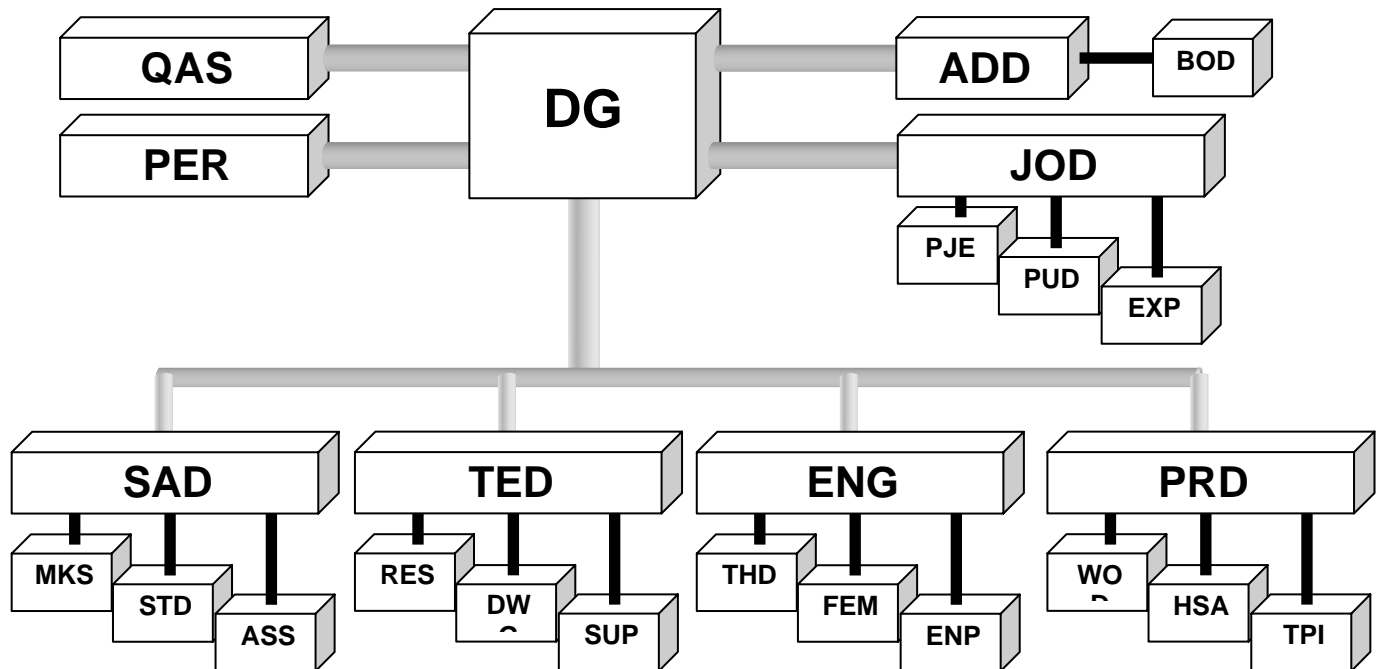

**DG** *Managing Direction*

**ADD** Administrative Department  
**BOD** Bookkeeping  
**PER** Human Resources  
**QAS** Quality Assurance Service

**JOD** *Operations Control Dept.*

**PUD** Purchase Department  
**EXP** Expediting  
**PJE** Project Engineering

**SAD** *Sales Department*

**MKS** Marketing Service  
**STD** Bidding Department  
**ASS** After Sales Service

**TED** *Technical Department*

**RES** Research & Development  
**DWG** Drawing  
**SUP** Commissioning & Supervisions

**ENG** *Engineering Department*

**THD** Thermal Design  
**FEM** Structural engineering  
**ENP** Engineering of production

**PRD** *Production Department*

**WOD** Workshop Department  
**HSA** Health and safety assurance  
**TPI** Training & permanent instruction



## V° MANAGEMENT

With reference to company structure resumed at page 6, following officers form our present management:

Managing Director	Dr. Ing. I. Rizzi
Chief of Operations	Dr. Ing. V. Nastro
Technical Manager	Dr. Ing. N. Facecchia
Chief of Engineering Dept.	Dr. Ing. R. Castagna
Sales Manager	Dr. Ing. F. Rizzi
Health and Safety	Dr. R. Kuznik



## VI° SALES ORGANIZATION

### 6.1 WORLDWIDE OPERATIONS

#### - OPERATIONS

We operate worldwide: in any moment our customers may contact us via E-MAIL and within 48 hours after request, one of our sales engineers is ready to move for visiting our customers worldwide.

#### - TECHNICAL MEETINGS

The contacts and the meetings are always made on the level of high technology engineering and never reduced only to cover commercial aspects.

#### - VIDEO CONFERENCE

We have organized our sales facilities in order to realize video conference with our customers.

### 6.2 AGENTS NETWORK

We have also a good network of agents covering many worldwide areas:

#### *AMERICAS*

U.S.A., Canada, Mexico, Colombia, Brazil, Argentina, Venezuela.

#### *EUROPE*

United Kingdom, Germany, Denmark, Belgium, The Netherlands, Monaco Principalty, Greece, France.

#### *ASIA & MIDDLE EAST*

Turkey, Syria, Jordan, Oman, Bahrein, Kuwait, Philippines, Pakistan, India, Bangladesh, People's Republic of China, South Korea, Japan, Malaysia.

#### *AFRICA*

Marocco, Tunisia, Egypt, Ghana, Ivory Coast, Senegal.



## **VI° SALES ORGANIZATION**

### **6.3 AFTER SALES SERVICE - ASS**

#### **- SITE ASSISTANCE**

We offer to our Customers also a continuous after sales service: in due time normally 48 hours after request, one of our supervision engineers is able to reach any refinery, or ship, or power station worldwide.

#### **- SPARE PARTS**

We guarantee that, for a period of 20 years after order date, spare parts can be found in our warehouse.

For equipments older than 20 years special arrangements are made to supply equivalent interchangeable parts.

#### **- ELECTRONIC FILES**

A safe electronic file system, separated from our internal electronic network assures the access to old files.

#### **6.3.1 Particular attention has been paid to cover worldwide areas.**

- MEDITERRANEAN AREA:  
We have a representative company in FRANCE – Marseille
- NORTH EUROPE AREA:  
We have organization company in DENMARK
- MIDDLE EAST AREA:  
We have a representative company in EGYPT - Cairo
- NORTH AMERICA AREA:  
We have a representative company in U.S.A - N.Y.
- SOUTH AMERICA AREA:  
We have a representative company in VENEZUELA - Caracas
- FAR EAST AREA:  
We have a representative company in JAPAN - Tokyo
- ASIA AREA:  
We have a representative company in INDIA - Bombay

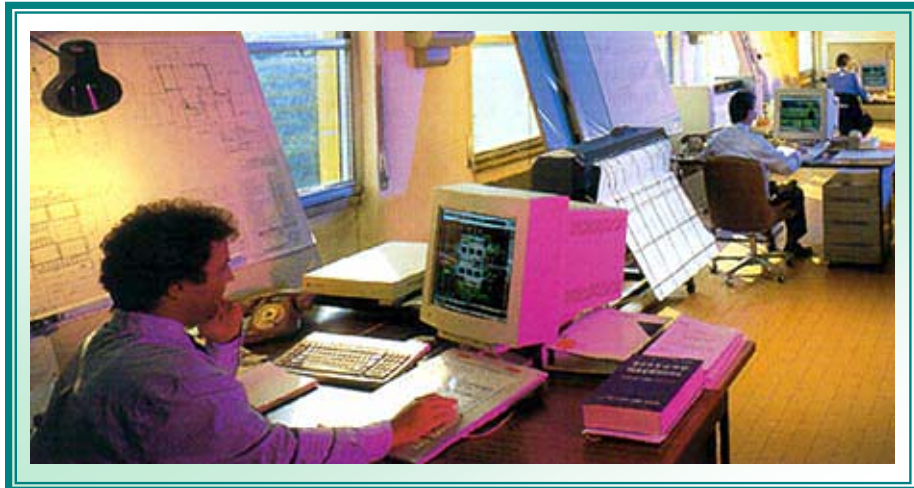

## VII° PRODUCTION PROGRAM



**CODE 13.000:** Design and engineering services for energy saving, heat transfer, mechanical design

---



**CODE 20.000:** Systems for solar energy, renewables field, energy conservation  
our SOL-AH / SOL-AIR DES-O-LAR types

---

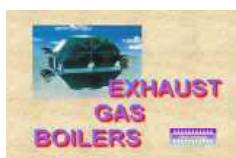

**CODE 30.000:** Waste heat recovery steam generators - exhaust gas boilers our DISEX patented type  
our INTEGRALFIN type

---



**CODE 50.000:** Fuel economizers for any size and type of steam generator  
our ENECOMIZER type

---



**CODE 60.000:** Combustion air preheaters - gas/gas heat exchangers  
our RAAG patented type

---



**CODE 71.000:** Extended surface heat exchangers  
our INTEGRALFIN and AXIAFIN type

---



**CODE 80.000:** Steam air preheaters and air cooled heat exchangers  
our AIREX type

---



**CODE 90.000:** Liquid cargo heating coils for any type of tanker or storage tank  
our TANK WARMING type

---



**CODE 110.000:** Cleaning Systems with any type of soot blowers  
our BLOWMATIC type



RIZZI ENGINEERING

*General Information on our Company*

MKS : 2.009	Comp. LD
Date : 07/01/2008	Contr. IC
Sheet : 13 of 31	Verif. DL

**RIZZI ENGINEERING s.r.l.** Via Nespolo, 8 - 25030 ADRO - Brescia - ITALY

## **VIII° PRODUCTS AND MAIN DESTINATIONS**

### **8.1 PETROCHEMICAL INDUSTRY AND OIL REFINERIES:**

- **COMBUSTION AIR PREHEATERS**  
recovering flue gas sensible heat
- **WASTE HEAT RECOVERY BOILERS**  
downstream process heaters
- **EXTENDED SURFACE HEAT EXCHANGERS**  
for high viscous fluids
- **AIR COOLERS AND AIR CONDENSERS**  
for areas with water shortage
- **SOOT BLOWERS**  
for refinery furnaces cleaning
- **STEAM AIR HEATERS**  
for refinery fired heaters

### **8.2 MARINE FIELD:**

- **EXHAUST GAS BOILERS**  
at service of marine diesel engines of any size and power
- **FUEL ECONOMIZERS**  
at service of marine steam boilers
- **CARGO HEATING SYSTEMS**  
at service of product carriers, tankers, VLCC, ULCC
- **FINNED TUBE HEAT EXCHANGERS**  
for fuel oil heating
- **STEAM CONDENSERS & HOTWELLS**  
for steam systems on M/V
- **STEAM AIR PREHEATERS**  
for marine steam boilers

### **8.3 SOLAR ENERGY AND RENOVABLES FIELD**

- **LOW PRESSURE SOLAR STEAM GENERATORS**  
for textile, food and pharmaceutical industry
- **SOLAR FLAT PANELS**  
for DHW and industrial applications
- **SEA WATER DESALTING PLANTS**  
for residential installations and agricultural purposes
- **SOLAR FLAT PANELS**  
for hot air production – drying systems



RIZZI ENGINEERING

*General Information on our Company*

MKS : 2.009

Comp. LD

Date : 07/01/2008

Contr. IC

Sheet : 14 of 31

Verif. DL

RIZZI ENGINEERING s.r.l. Via Nespolo, 8 - 25030 ADRO - Brescia - ITALY

## VIII° PRODUCTS AND MAIN DESTINATION

### 8.4 THERMAL POWER STATIONS:

- FUEL ECONOMIZERS  
for any size of steam generators
- WASTE HEAT RECOVERY STEAM GENERATORS  
for combined cycles plants and cogeneration systems
- RECUPERATIVE COMBUSTION AIR PREHEATERS  
for any size of steam generators
- SOOT BLOWERS  
for steam generators cleaning
- AIR COOLERS AND CONDENSERS  
for areas with water shortage
- EXTENDED SURFACE HEAT EXCHANGERS  
for fuel oil heating
- STORAGE TANKS HEATING SYSTEMS  
for fuel oil heating
- STEAM AIR PREHEATERS  
for any type of steam generator

### 8.5 STEEL AND METALLURGICAL INDUSTRY:

- WASTE HEAT RECOVERY BOILERS  
fit for coke dry quenching and sintering plants
- HEAT RECOVERY SYSTEMS  
for treating furnaces
- GAS AND AIR HEATERS  
for retrofitting blast furnaces after Cowper systems
- ECONOMIZERS - AIR HEATERS – ECONAIRE - COMBINED SYSTEMS  
for power stations using blast furnace gas or coke gas

### 8.6 SUGAR MILLS - PAPER MILLS - TEXTILE INDUSTRY

- FUEL ECONOMIZERS  
for any type of steam boiler
- COMBUSTION AIR PREHEATERS  
for sensible heat recovery
- SOOT BLOWERS  
for steam boilers cleaning



RIZZI ENGINEERING

**General Information on our Company**

MKS : 2.009	Comp. LD
Date : 07/01/2008	Contr. IC
Sheet : 15 of 31	Verif. DL

RIZZI ENGINEERING s.r.l. Via Nespolo, 8 - 25030 ADRO - Brescia - ITALY

## IX° DESIGN AND ENGINEERING SERVICES

Our Company since 1938 has been designing and supplying engineering for energy saving systems and heat transfer equipments. To day up-to date CAE and CAD systems are extensively used, utilizing our own safe and protected network.

### 9.1 SPECIFIC KNOW-HOW

Our company doesn't manufacture under know-how or licences of Others, but only on the basis of its own specific know-how.

Engineering software and manufacturing know-how are company's property and aren't in any case object of sales to third parties.

Any attempt to get hold of our know-how cause immediate break off of any contract.

### 9.2 FACILITIES

The facilities for design and engineering are situated in our head-office building with a surface of 1.000 square meters. An advanced network of computers and workstations fit for CAE and CAD is installed, connecting all departments.

### 9.3 CALCULATION SYSTEMS

Our technical and engineering department uses up-to-date methodologies for designing and engineering. For the basic and detailed engineering there are used CAD and CAE systems.

CAE software has been developed by RIZZI ENERGY throughout, on the basis of more than 65 years of experience. Also finite elements analysis is applied.

Among others we use the following calculation codes:

#### Thermal calculation:

- ASME
- WÄRMEATLAS
- HEI
- API

#### Mechanical calculation

- VSG/VSR Italian rules
- LLRS Rules English rules
- CODAP French rules
- ADM/TRD German rules
- ABS American rules
- ASME American rules
- IBR Code Indian rules

### 9.4 PATENTS AND TECHNOLOGIES

Our Company holds the following particularly qualified patents and technologies:

- Air preheater with double extended surface:.....**our RAAG type**
- Exhaust gas boiler for diesel engines:.....**our DISEX type**
- Liquid cargo heating system : .....**our TANKWARMING type**
- Superlight finned tube for marine economizer : .....**our FMA type**

## X° TESTING FACILITIES

In order to verify all necessary design parameters, we've organized a testing area where we've realized some full scale experimental plants. In this area we make tests for heat transfer, control of flow and pressure drops of gases and liquids, mechanical feasibility and fatigue failure for various components.



The above picture illustrates and equipment for heat transfer testing during calibration activities. The power is supplied by a set of electric resistances.



## X° TESTING FACILITIES

Many different parameters of finned tube bundles, like fins and tube diameters, type of finning, transversal and longitudinal pitches, have been tested.  
Many comparison have been carried out both for enhanced heat transfer and pressure drops.



The above picture refers to a multipass heat exchangers realized by four horizontally settled modules.  
Each module can be removed and changed to test different tube bundles.

## X° TESTING FACILITIES

View of our testing area for R & D.  
In this area it is possible to probe full scale equipments.



Testing for mechanical reliability of a longstroke retractable lance soot blower.  
The picture shows also the apparatus simulating steam pressure at valve inlet.  
Long lasting test have been carried out for different supports types and lubricating devices.

## **XI° WORKSHOP**

### **11.1 RESUMING FEATURES**

- Whole area m<sup>2</sup> 30.000
- Machinery area m<sup>2</sup> 6.000
- Number of working bays N° 12
- Covered storage area m<sup>2</sup> 5.000

Works are located at 20 Km west from Brescia and 80 km east from Milan very close to the motorway Venice-Milan, in the middle of Lombardia region, between Genoa Port west direction and Venice Port east direction.

### **11.2 FACILITIES**

Workshop is organized in 12 bays equipped with specific dedicated machinery for mechanical construction, pressure parts manufacturing, electrical assembling and carpentry production. All bays are fully served by lifting devices for materials handling.

### **11.3 FINNING EQUIPMENTS**

Particularly in our workshop there are installed lines of production for following specific products:

- Finned tubes line with welded steel fins
- Bi-metallic steel and cast iron finned tubes
- Air heater with internal and external fins
- Bimetallic aluminium and steel finned tubes line
- Low radial finning process



## XI° **WORKSHOP**

### **11.4 COMBUSTION AIR PREHEATERS BAY**

The picture shows 10 modules fully assemble of a C.A.PH. destined to an hydrogen plant.

### **11.5 CLEAN AREAS**

One clean area is provided for the manufacturing of electrical and electronic control panel boards.  
A second clean area is provided if necessary for production involving stainless steel

### **11.6 HEALTH & SAFETY ASSURANCE**

Our HSA service carries out following activities:

- Micro-climate periodic controls
- Noise, oil, gas and other pollutants countinuos monitoring
- Ergonomics and medical periodic controls.

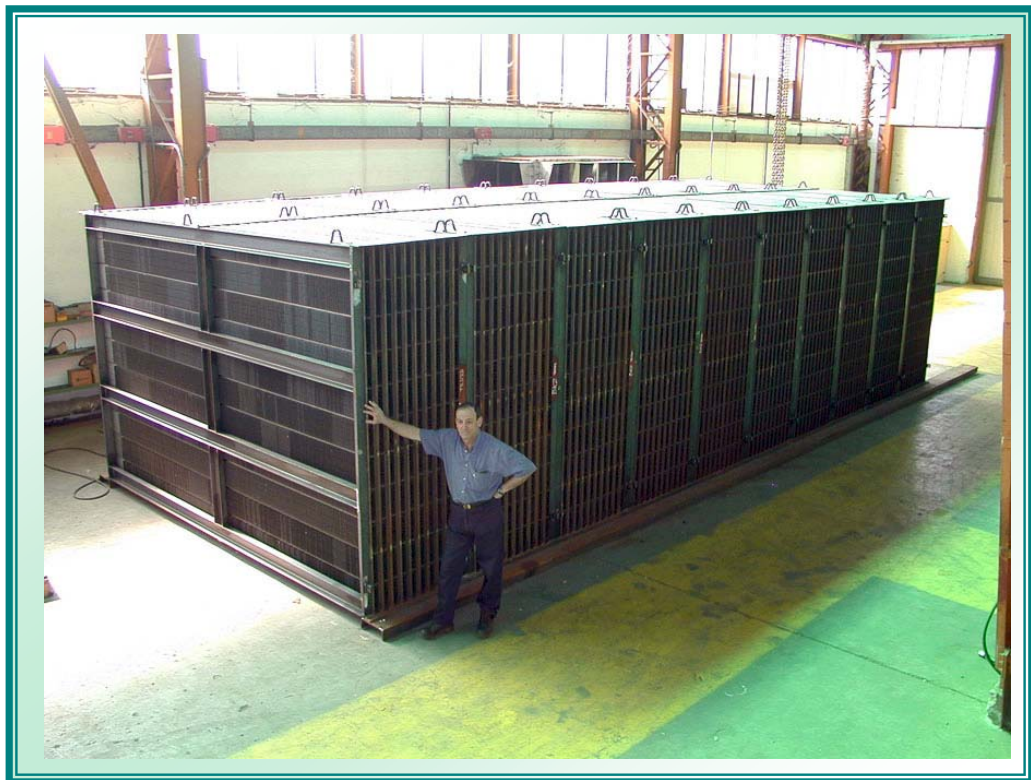

## **XII° QUALITY ASSURANCE SYSTEM**

### **12.1 GENERAL DESCRIPTION**

The quality assurance service of our Company has been established in 1960 to survey the manufacturing of systems or components for marine field and power stations.

Today QAS covers the whole range of our activity and now it has been improved in order to cope with ISO 9000 standards.

The QA service guarantees the reliability of our engineering, the quality of the manufactured products and the conformity to design specifications.

Our quality assurance / quality control book is continuously up-graded and submitted to Inspection Authorities, when required.

### **12.2 THIRD PART INSPECTION AND TESTING**

Our company operates in accordance with quality assurance procedures certificated by ourselves, furthermore third part inspection authorities are always involved in the quality assurance guarantee.

Our equipments have been tested, for example, by these inspection authorities:

- **R.I.Na**
- **I.S.P.E.S.L.**
- **Lloyd's Register of Shipping**
- **LLR Industrial Survey**
- **Det Norske Veritas**
- **Bureau Veritas**
- **APAVE**
- **TÜV**
- **Germanisher Lloyd**

Consequently our Company, our engineering services and our equipments have been approved by many classification authorities.



**XII° QUALITY ASSURANCE SYSTEM**

**12.3 TYPICAL THIRD PARTS INSPECTION APPROVALS**

For pressure parts design and construction we've been approved, also by LLR



Certificate No : MD00/2591/0002/PC

Rizzi Energy S.P.A.  
Via Nespolo 6  
25030 Torbiato Adro  
Brescia  
Italy

has been approved as a manufacturer in accordance with the requirements of Lloyd's Register for :-

**Fusion Welded Pressure Vessels Class 2.2**

This approval is subject to compliance with the Lloyd's Register Rules for the Classification of Ships. The full details of the processes, products and grades to which this approval applies are given in the Appendix of this certificate.

Lloyd's Register is to be notified of any change that may affect the validity of this Certificate.

This Certificate is issued to the above manufacturer and is valid until the date given below.

Valid Until : 06 June 2007  
Date of Issue : 01 September 2004

**C Davin**  
Surveyor to Lloyd's Register EMEA  
A member of Lloyd's Register Group





**NOTICE - This certificate is subject to the terms and conditions overleaf**

**XII° QUALITY ASSURANCE SYSTEM**

**12.3 TYPICAL THIRD PARTS INSPECTION APPROVALS**

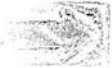
For pressure parts design and construction we've been approved, also by I.S.P.E.S.L.

 Ministero della Salute	ISTITUTO SUPERIORE PER LA PREVENZIONE E LA SICUREZZA DEL LAVORO DIPARTIMENTO TECNOLOGIE DI SICUREZZA IX^ UNITA' FUNZIONALE Laboratorio Chimico e Tecnologico per i materiali	00133 Roma ..... Via Torraccio di Torrenova, 7 Tel. 06209431 Fax 062052358								
<table border="1" style="width: 100%;"> <tr> <td colspan="2">DTS IX U.F. /</td> </tr> <tr> <td colspan="2">ISPESL - Sede Centrale</td> </tr> <tr> <td style="width: 50%;">010705</td> <td style="width: 50%;">17.SET 02</td> </tr> <tr> <td colspan="2">PROTOCOLLO</td> </tr> </table>	DTS IX U.F. /		ISPESL - Sede Centrale		010705	17.SET 02	PROTOCOLLO			<b>Spett.le Soc.</b> <b>RIZZI ENERGY SPA</b> Via Nespolo, 8 <b>25030 ADRO BS</b>
DTS IX U.F. /										
ISPESL - Sede Centrale										
010705	17.SET 02									
PROTOCOLLO										
e p.c. Al Dipartimento Omologazione e Certificazione										
<b><u>SEDE</u></b>										
Oggetto: Richiesta qualifica costruttore. Raccolta "S" - rev. 95. Cap. S.0.2.										
Con riferimento alla domanda presentata per l'ottenimento della Qualifica prevista al Cap. S.0.2 della Raccolta "S"- Rev. 95, ed al successivo invio di documentazione integrativa, si comunica che dall'esame della citata documentazione, effettuata dal Laboratorio Chimico e Tecnologico di questo Dipartimento, risulta che codesta Ditta possiede i requisiti di base per svolgere attività di saldatura per la costruzione di apparecchi in pressione.										
Il Direttore del Dipartimento (Dott. Ing. Roberto CIANOTTI)										
 EC										

**XII° QUALITY ASSURANCE SYSTEM**

**12.3 TYPICAL THIRD PARTS INSPECTION APPROVALS**

For pressure parts design and construction we've been approved, also by  
DET NORKE VERITAS

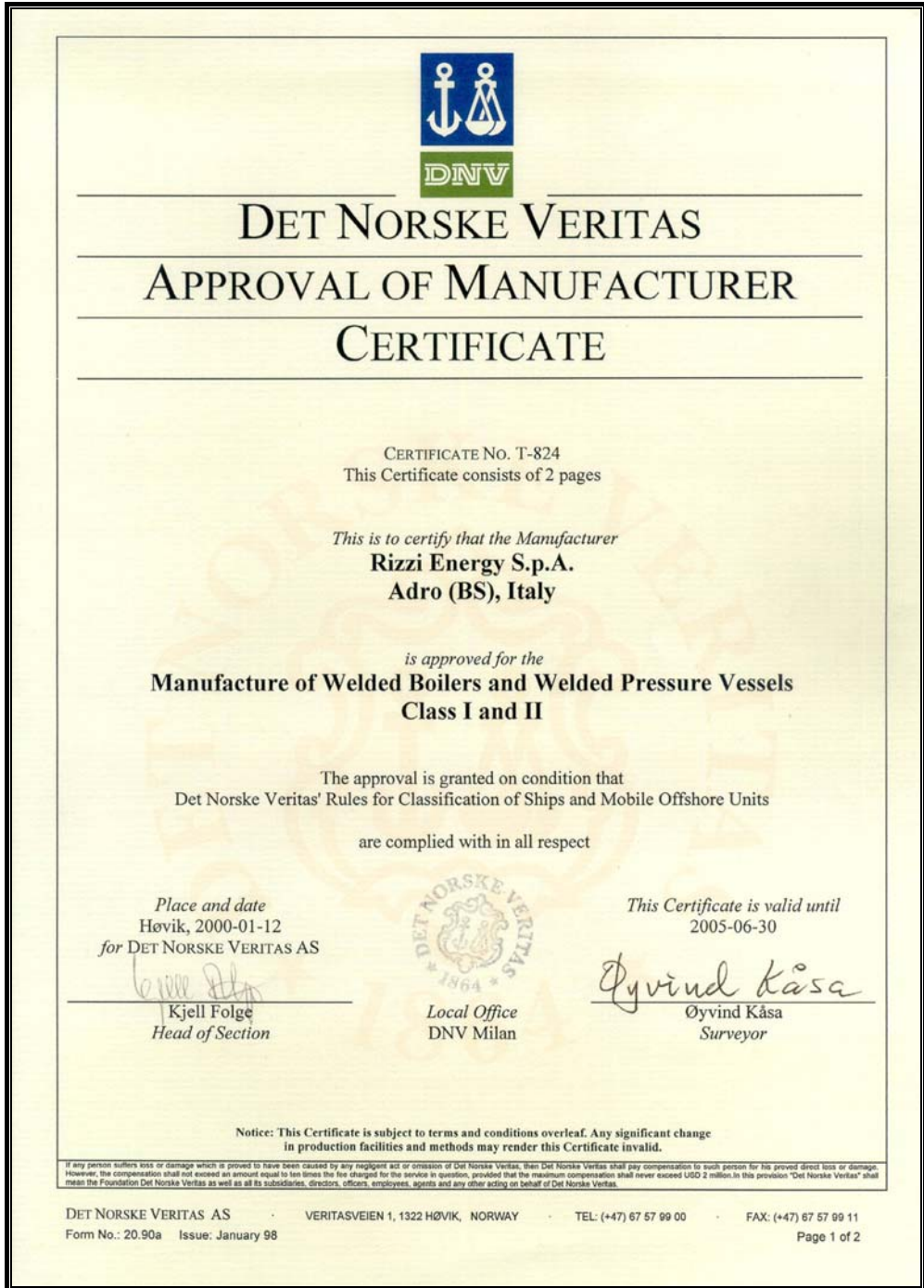





RIZZI ENGINEERING

*General Information on our Company*

MKS : 2.009	Comp. LD
Date : 07/01/2008	Contr. IC
Sheet : 25 of 31	Verif. DL

RIZZI ENGINEERING s.r.l. Via Nespolo, 8 - 25030 ADRO - Brescia - ITALY

## **XII° QUALITY ASSURANCE SYSTEM**

### **12.4 INTERNATIONAL RULES AND STANDARDS**

Our plants are realized according to the strictest standards of national and international codes, as for instance:

- **ISPESL - VSG/VS**
- **TÜV**
- **ADM - MARKBLATTEN**
- **AFNOR**
- **CODAP**
- **STOOMWEZEN**
- **IEC**
- **VDE**
- **CEI**
- **INDIAN BOILER CODE**
- **TEMA**
- **ASTM**
- **ASME**
- **UNI**
- **DIN**

### **12.5 WELDINGS WPS**

All welding operations are carried out in accordance with WPS specifications supported by our procedures:

- **PQR**
- **WPQ**

issued in accordance with ASME IX and certified by many different Inspection Authorities

All procedures are in accordance with our quality assurance / quality control book.

## XII° QUALITY ASSURANCE SYSTEM

### 12.6 ISO 9001 SQS CERTIFICATE



## Certificate

SQS herewith certifies that the company named below has a management system which meets the requirements of the normative base specified below.



**Rizzi Engineering S.r.l.**  
**Via Nespolo, 8**  
**IT-25030 Adro (BS)**

Certified area

**Whole Company**

Field of activity

**Design, manufacturing and installation  
of energy saving and heat recovery systems  
and equipments**

Normative base

**ISO 9001:2000 Quality Management System**

Swiss Association for Quality and  
Management Systems SQS  
Bernstrasse 103, CH-3052 Zollikofen  
Issue date: March 10, 2008

This SQS Certificate is valid up to  
and including March 9, 2011  
Scope number 17  
Registration number 33656

*X. Edelmann*  
X. Edelmann, President SQS

*T. Zahner*  
T. Zahner, Managing Director SQS



**XII° QUALITY ASSURANCE SYSTEM**

**12.7 ISO 9000 IQNET CERTIFICATE**



THE INTERNATIONAL CERTIFICATION NETWORK

# CERTIFICATE

IQNet and SQS  
hereby certify that the organization

**Rizzi Engineering S.r.l.**  
Via Nespolo, 8  
IT-25030 Adro (BS)

*Certified area*

**Whole Company**

*Field of activity*

**Design, manufacturing and installation of energy saving  
and heat recovery systems and equipments**

has implemented and maintains a  
**Management System**  
which fulfills the requirements of the following standard

**ISO 9001:2000**

Scope No: 17  
Issued on: 2008-03-10  
Validity date: 2011-03-09  
Registration Number: **CH-33656**



*René Wasmer*  
President of IQNet



*Theodor Zahner*  
Managing Director SQS



*IQNet Partners\*:*

AENOR Spain AFAQ AFNOR France AIB-Vinçotte International Belgium ANCE Mexico APCER Portugal CISO Italy CQC China  
CQM China CQS Czech Republic Cro Cert Croatia DQS Germany DS Denmark ELOT Greece FCAV Brazil  
FONDONORMA Venezuela HKQAA Hong Kong China ICONTEC Colombia IMNC Mexico Inspecta Certification Finland  
IRAM Argentina JQA Japan KFQ Korea MSZT Hungary Nemko AS Norway NSAI Ireland PCBC Poland QMI Canada  
Quality Austria Austria RR Russia SAI Global Australia SII Israel SIQ Slovenia SIRIM QAS International Malaysia  
SQS Switzerland SRAC Romania TEST St Petersburg Russia YUQS Serbia

IQNet is represented in the USA by: AFAQ AFNOR, AIB-Vinçotte International, CISO, DQS, NSAI Inc., QMI and SAI Global

\* The list of IQNet partners is valid at the time of issue of this certificate. Updated information is available under [www.iqnet-certification.com](http://www.iqnet-certification.com)

**XII° QUALITY ASSURANCE SYSTEM**

**12.8 OIL INDUSTRY SUPPLIER CERTIFICATE FOR OFFSHORE SYSTEMS**



**Achilles**  
Joint Qualification System  
*for suppliers to the Oil Industry in Norway and Denmark*

**Certificate of Qualification**  
*Awarded to*

**RIZZI ENERGY**

*Achilles Id. 25918*

*Achilles Information Centre hereby confirms that  
RIZZI ENERGY  
is qualified in the Achilles Joint Qualification System  
for suppliers to the Oil Industry in Norway and Denmark.  
The qualification concerns the product and service  
categories listed in the appendix.*

 Oddvar Gjovik Achilles Information Centre Managing Director	Issued Date: 23-des-2005	Expiry Date: 22-Dec-2006
--	-----------------------------	-----------------------------



RIZZI ENGINEERING

*General Information on our Company*

MKS : 2.009	Comp. LD
Date : 07/01/2008	Contr. IC
Sheet : 29 of 31	Verif. DL

RIZZI ENGINEERING s.r.l. Via Nespolo, 8 - 25030 ADRO - Brescia - ITALY

## **XIII° CATEGORIES OF CUSTOMERS**

### **13.1 LIST OF CATEGORIES**

Our customers belong to the categories below listed and for each category a typical reference is indicated.

- THERMAL POWER STATIONS / ELECTRICITY BOARDS
- PETROCHEMICAL INDUSTRIES / OIL REFINERIES
- SHIPYARDS / SHIPOWNERS / SHIP MANAGEMENT
- STEEL & IRON INDUSTRIES / METALLURGICAL INDUSTRIES
- STEAM GENERATORS MANUFACTURERS
- FIRED HEATERS MANUFACTURES
- DIESEL ENGINES MANUFACTURERS
- GAS TURBINES MANUFACTURERS
- FOOD INDUSTRIES / SUGAR MILLS / BREWERIES
- LARGE MECHANICAL INDUSTRIES
- STORAGE TANKS MANUFACTURERS
- PAPER MILLS / WOOD INDUSTRIES
- ENGINEERING COMPANIES / MAIN CONTRACTORS
- TEXTILE INDUSTRIES
- GLASS PRODUCERS
- HOSPITALS AND PHARMACEUTICAL INDUSTRIES

### **13.2 MAIN AREAS OF ACTIVITY**

Our activity is mainly oriented toward the following four areas:

- Hydrocarbon industry
- Shipbuilding industry and shipowners
- Power stations and electricity boards
- Solar energy field



RIZZI ENGINEERING

**General Information on our Company**

MKS : 2.009 Comp. LD

Date : 07/01/2008 Contr. IC

Sheet : 30 of 31 Verif. DL

RIZZI ENGINEERING s.r.l. Via Nespolo, 8 - 25030 ADRO - Brescia - ITALY

**XIV° LIST of CUSTOMERS for typical samples**

## 14.1 ELECTRICITY BOARDS

SNIM	Nouhadibou	Mauritanie	Waste heat boilers
ENEL S.p.A	Civitavecchia	Italy	Air heaters
EEA Ltd	Cairo South	Egypt	Fuel economizers
DEI (PPC)	Islands	Greece	Waste heat boilers
Comp. El.del Nordeste	Porto Velho	Brazil	Waste heat boilers
ONE SA	Kenitra	Maroc	Air preheaters

## 14.2 PETROCHEMICAL INDUSTRY

Hindustan Petroleum Co.	Visakhapatnam	India	Soot blowers
Saras S.p.A.	Sarroch	Italy	Soot blowers
Petrokimia Gresik	Java	Indonesia	Fuel economizers
Agip Raffinazione S.p.A.	Taranto-Sannazzaro	Italy	Combustion air heaters
Conoco	South Killingholme	England	Combustion air heaters
Tamoil	Cremona	Italy	Heat exchangers

## 14.3 SHIPYARD &amp; SHIPOWNERS

Fincantieri S.p.A.	Trieste	Italy	Exhaust gas boilers
Carnival Cruise	Miami	U.S.A.	Exhaust gas boilers
Mediterranean Shipping Co.	Geneva	Switzerland	Exhaust gas boilers
Maritime Overseas Corp.	New York	USA	Fuel economizers
Astano	El Ferrol	Spain	Fuel economizers

## 14.4 STEEL INDUSTRY

Italsider S.p.A.	Taranto	Italy	Fuel economizers
Acciaieria Pietra S.p.A	Brescia	Italy	Combustion air heaters
Siderurgica de Tubarao	Tubarao	Brazil	Waste heat boilers

## 14.5 ENGINEERING COMPANIES

Snamprogetti Ltd	Basingstoke	U.K.	Combustion air heaters
JGC Corp.	Yokohama	Japan	Soot blowers
Foster Wheeler Italiana SpA	Corsico	Italy	Combustion air heaters
Engineers of India Ltd.	New Delhi	India	Soot blowers
Technip Group	Roma/Paris	France	Steam air heaters
Mitsubishi Heavy Ind. Ltd.	Yokohama	Japan	Steam air heaters

## 14.6 FIRED HEATERS MANUFACTURERS

Born Heater Ltd	Southwick	U.K.	Combustion air heaters
Kirchner Italia S.p.A.	Milano	Italy	Combustion air heaters
Heurtey Petrochem S.A.	Paris	France	Soot blowers
Petrochem Development Co.	New York	U.S.A.	Steam air heaters

## 14.7 POWER STATION MANUFACTURERS

Ansaldo S.p.A.	Genova	Italy	Fuel economizers
SEMT Pielstick	St. Denis	France	Waste heat boilers
Babcock Entreprise	La Courneuve	France	Fuel economizers

## 14.8 MECHANICAL INDUSTRY

Fiat S.p.A.	Rivalta	Italy	Combustion air heaters
Pinin Farina S.p.A.	Grugliasco	Italy	Combustion air heaters
Alenia S.p.A.	Pomigliano d'Arco	Italy	Fuel economizers



## XV° BANK REFERENCES AND FINANCIAL DATA

### 15.1 BANK REFERENCES

Our company works with the following European banks:

- **Banco di Brescia - Sede di Brescia**  
Address: Corso Martiri della Libertà, 13 - BRESCIA – ITALY  
ACCOUNT N° 55195 ABI CODE 03500 CAB 11200
- **Credito Bergamasco - Agenzia di Timoline**  
Address: Via Roma, 77 - 25050 TIMOLINE (BS) – ITALY  
ACCOUNT N° 4532 ABI CODE 03336 CAB 54420
- **Banca dell'Artigianato e dell'Industria - Filiale di Iseo**  
Address: Via Ninfea, 2/4, 25049 – ISEO (BS) – ITALY  
ACCOUNT N° 6792 ABI CODE 03078 CAB 54610
- **Banca Intesa San Paolo IMI - Filiale di Rovato**  
Address: Largo Cattaneo, 8 – 25038 ROVATO (BS) – ITALY  
ACCOUNT N° 1000/00002213 ABI CODE 03069 CAB 55142
- **Deutsche Bank - Filiale di Erbusco**  
Address: Via Provinciale, 22/A – 25030 ERBUSCO (BS) – ITALY  
ACCOUNT N° 820059 ABI CODE 03104 CAB 54480

### 15.2 TURNOVER SPLIT

Our turnover is spread on different areas of activity:  
the average percentages are the following ones:

- |                       |   |    |
|-----------------------|---|----|
| ➤ Hydrocarbon field   | % | 30 |
| ➤ Shipping industry   | % | 16 |
| ➤ Power stations      | % | 16 |
| ➤ Energy conservation | % | 20 |
| ➤ Heat transfer       | % | 18 |